

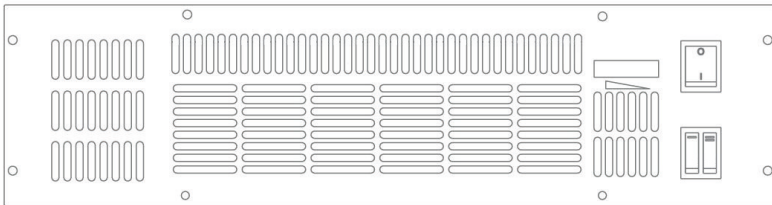

Product Instruction Manual
Mistral













ML2400
Plinth Heater

Overview

Thank you for purchasing a Mistral Plinth heater. It will provide heat in a kitchen where space is at a premium.

Please read and follow these instructions to ensure that installation and operation are as simple and safe as possible.

Important Safety Points

-  This appliance can be used by children aged from 8 years and above and persons with reduced physical, sensory or mental capabilities or lack of experience and knowledge if they have been given supervision or instruction concerning use of the appliance in a safe way and understand the hazards involved.
-  Children of less than 3 years should be kept away unless continuously supervised.
-  Children aged from 3 years and less than 8 years shall only switch on/off the appliance provided that it has been placed or installed in its intended normal operating position and they have been given supervision or instruction concerning use of the appliance in a safe way and understand the hazards involved.
-  Children aged from 3 years and less than 8 years shall not plug in, regulate, and clean the appliance or perform user maintenance.
-  Children shall not play with the appliance.
-  Cleaning and user maintenance shall not be made by children without supervision.
-  CAUTION — Some parts of this appliance can become very hot and cause burns. Particular attention has to be given where children and vulnerable people are present.
-  If the supply cord is damaged, it must be replaced by the manufacturer, its service agent or similarly qualified persons in order to avoid a hazard.
-  WARNING: In order to avoid overheating, do not cover the heater.
-  The appliance must not be located immediately below a socket outlet.
-  This appliance is not designed for outdoor use or use in very damp conditions.



This appliance should only be installed and maintained by a competent person in accordance with any local electrical regulations.



Only connect the appliance to an electrical supply that meets the specification detailed on the rating label.

1. Installation



Ensure there are no hidden cables or pipework before commencing any drilling.



The appliance is only intended for horizontal installation, fire risk exists if installed in any other orientation.

- This appliance is designed to fit to a plinth or board and below the base shelf of a kitchen-type cupboard within the free plinth space/ void.
- This appliance is cable pre wired (2 m) and should be permanently connected to the electricity supply via a double pole switch having 3 mm gap on each pole.
- Remove the selected plinth and cut a hole in it (see diagram 1 and 2).
- The power supply cable must then be fed from the double pole switch into the free plinth space/ void. The cable must be long enough to withdraw the appliance from the plinth if maintenance is required. Ensure no sharp edges are present along the power cable route.
- Offer up the appliance to the plinth, mark the fixing holes and secure to the plinth with the colour match screws. The black fascia is permanently fixed to the appliance, the other colour fascias are fixed on top of the black fascia panel if desired, using the appropriate colour match screws.
- Position the plinth (the appliance should be resting on all four feet) and secure plinth using suitable fixings.
- Connect the appliance to the mains power supply as per section 2.
- To remove the appliance from the plinth space, should maintenance be required, disconnect mains power supply, unscrew fascia panel and slide appliance out.

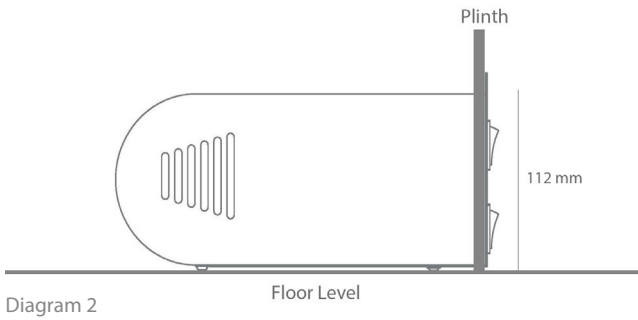
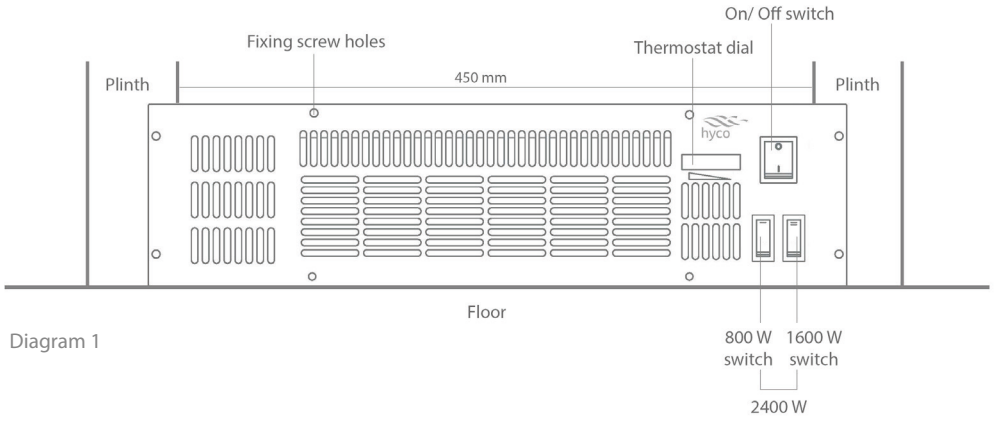

2. Electrical Connection



The appliance must be permanently connected to the electrical supply through an appropriately rated isolating switch with a contact separation in all poles.









This appliance must be earthed.

- Electrical connection should be made via a 13A switched fuse spur.
- Make connections as below;
 - Green/ yellow earth wire to terminal marked ⊕
 - Brown live wire to the terminal marked 'L'
 - Blue neutral wire to the terminal marked 'N'

3. Operation

- Turn on power to the appliance.
- Choose from 3 heat settings, 800 W, 1600 W and 2400 W or fan only option (see diagram 1).
- Using only the large top switch, the fan will run and blow cold air.
- Using the left hand small switch only will produce 800 W of heat. The right hand switch only will deliver 1600 W of heat.
- With both switches operated the maximum heat setting of 2400 W will be achieved.
- Select your desired room temperature using the thermostat dial.
- The heating element and fan will switch off when the desired room temperature has been reached. If room temperature drops below the chosen level the element and fan will switch back on.
- This appliance is fitted with a safety device which switches off the heater if, for any reason, the appliance overheats. The appliance can only be reset after it has cooled down. In order to reset the safety device proceed as follows.
 - Switch off appliance and leave for approximately 5 minutes.
 - Switch on appliance and safety device will reset.
 - Ensure that the appliance is functioning correctly. If the safety device operates again, the appliance should be checked by a competent electrician or service engineer.

4. Cleaning and Maintenance

-  Ensure any future maintenance or modifications to the appliance complies with the guidelines in these instructions.
 -  Keep records of maintenance and ensure any future occupier of the building is fully aware of the content of these instructions.
 -  Isolate the appliance from the electrical supply before performing any maintenance task.
 -  Ensure the appliance has cooled down before performing any maintenance task.
 -  Do not use abrasive materials or chemicals to clean this appliance.
 -  Use a soft damp cloth when cleaning, avoid excessive use of liquids.
- Use a soft brush or vacuum cleaner to gently remove any dust or debris that could adversely affect the airflow through and around the appliance.

5. Specification

Model	ML2400
Power	2.4 kW
Voltage	230 V
Heat settings	800 W, 1600 W, 2400 W
Dimensions (h x w x d)	125 x 480 x 215 mm
Weight	4.7 kg

6. Guarantee and Service Policy

This product is covered by a standard parts or replacement warranty for a period of 1 year from the date of purchase.

If there is a manufacturing defect within the warranty period we will send spare parts, repair and return the unit or, at our discretion, supply a replacement product. Incorrect installation, frost damage, the consequences of limescale deposits or failure to follow correct operating and maintenance instructions are excluded. Consequential costs such as labour charges or damage to fittings and surroundings are expressly excluded.

7. Contact Us

If you experience a problem with this product you should first contact our service department on 01924 225 200 before taking any further action. Experience has shown that issues can often be resolved without the need to return or uninstall the product.



INFORMATION FOR CORRECT DISPOSAL OF THE PRODUCT IN ACCORDANCE WITH THE EUROPEAN DIRECTIVE 2012/19/EU.

At the end of its working life this equipment must not be disposed of as household waste. It must be taken to a local authority waste collection centre or to a dealer providing this service. Disposing of electrical and electronic equipment separately enables its components to be recovered and recycled to obtain significant savings in energy and resources. In order to underline the duty to dispose of this equipment separately, the product is marked with a crossed out dustbin.

Hyco Manufacturing Ltd
Normandy Court
Express Way
Castleford, WF10 5NR

hyco.co.uk

T 01924 225 200
E sales@hyco.co.uk