

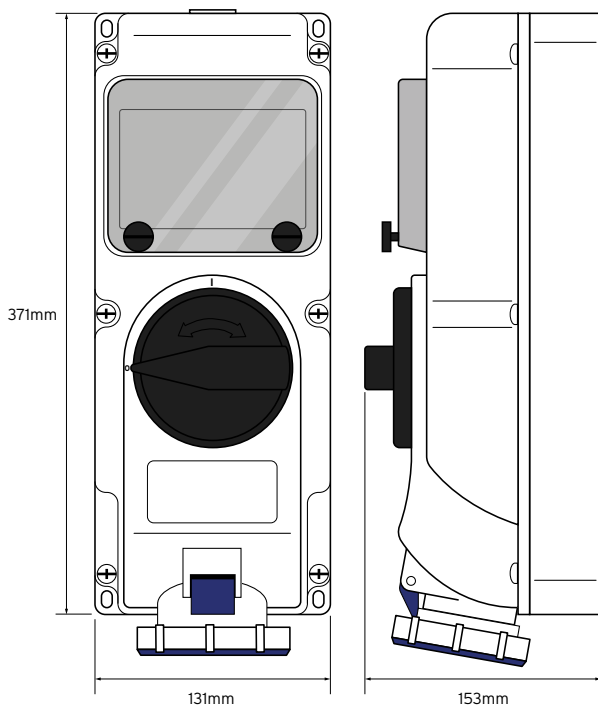

18766

IP66 Wall Mounted Interlocking Switched Socket

Technical Drawing



Technical Specifications

Material Composition	PC/ABS Housing
Amps	32A
Volts	240V
Poles	3
Pin Configuration	2 p + E
Wire Flexible mm ²	2.5-6
Wire solid mm ²	2.5-10
IP Rating	IP66
Certified	ÖVE & CE
Standards	BS EN 60309-1&2
Dimensions	371 x 131 x 153mm
Knockouts	3x25

