

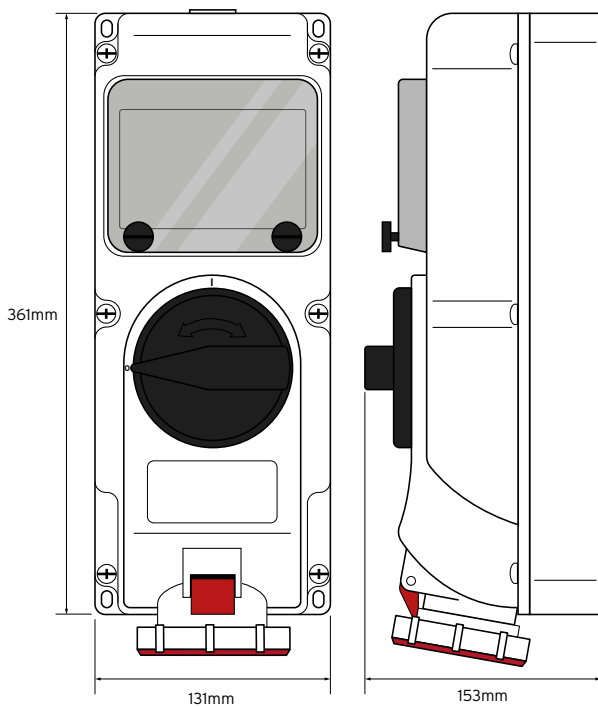

18758

IP66 Wall Mounted Interlocking Switched Socket

Technical Drawing



Technical Specifications

Material Composition	PC/ABS Housing
Amps	16A
Volts	415V
Poles	4
Pin Configuration	3 p + E
Wire Flexible mm ²	1.5-2.5
Wire solid mm ²	1.5-4
IP Rating	IP66
Certified	ÖVE & CE
Standards	BS EN 60309-1&2
Dimensions	361 x 131 x 153 mm
Knockouts mm	3x25 M

